



让光科技生态化

Make The Light Technology Ecologically



www.ledguhon.com

☎ **020-66826655**

广州市巨宏光电有限公司

Guangzhou Juhong Optoelectronics Co., Ltd.



企业简介 Company profile

广州市巨宏光电有限公司，座落于美丽的花城广州市，是一家聚研发、生产、销售、服务为一体的高科技企业。

公司成立于2009年,主要生产直插灯珠，大功率灯珠，集成灯珠和陶瓷灯珠(Lamp LED,High power LED,COB LED,SMD LED)，倡导以品质为本公司的生命，以市场信息决定未来的方向。

公司的发展远景是将客户的利益放在第一位置，建立双赢的合作伙伴是我们的目标，建立全球化环保节能是我们的本份，在未来的发展旅途中我们将以热诚的态度为广大客户提供高品质的服务,也将努力提供高效率的服务，创造共同的价值观，添增LED行业的辉煌，共享其果，携手共进.....

Guangzhou Juhong Optoelectronics Co., Ltd., located in Guangzhou which is a beautiful Flower City,focused on the research and development, production, sales, and service of LED as well as a high-tech enterprise.

Our company was founded in 2009 .Our products are mainly about Lamp LED,High power LED,COB LED and SMD LED. Advocate that quality is the life of our company.And we believe that the market decides the direction of the future.

Our company vision is to put the customers' interests in the first. Our goal is to establish a win-win partnership.Our duty is to create awareness of environmental protection and energy saving. In the future development of company's journey.We will be glad to providing our customers with high quality service and try our best to provide efficient service, creation of common values, add the honor of LED industry ,share their fruit and join hands together.

使命：让光科技生态化

愿景：分享LED光科技生态化，
让巨宏智造成为东方品牌，
引领生态光源在全球绽放！

价值观：无我、利他、诚信、匠心、创新



Company Mission

Make the light technology ecologically

Company Vision

Share LED light technology ecologically,
Let Juhong become the oriental brand,
Lead ecological light source bloom globally!



Company Value

Selfless、Altruism、Integrity、Ingenuity、Innovation

代表性产品展示 Main products show

陶瓷灯珠系列

SMD Ceramic led series



SMD贴片系列

SMD patch series



代表性产品展示 Main products show

仿流明系列

High power series

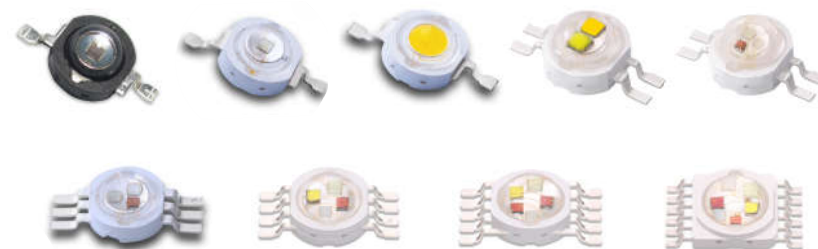

集成模组系列

COB Integrated module series



直插系列

Lamp led series



陶瓷灯珠系列 SMD Ceramic led series

陶瓷3535白光 3535 Ceramic white SMD led

产品规格 Product dimension

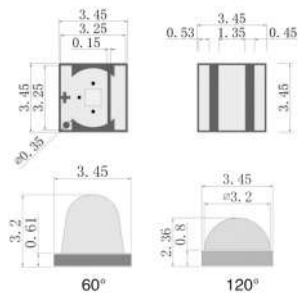

产品型号 Part No.	功率 Power(W)	色温 CCT(K)	光通量 Luminous Flux(lm)	电压 Forward Voltage(V)	电流 Forward Current(mA)	角度 Angle(deg)	显色指数 CRI
JH-3535W(6/12)U27-T7A	1	5500-6500	100-120	3.0-3.4	350	60/120	75
JH-3535WW(6/12)U27-T7A	1	2800-3200	90-110	3.0-3.4	350	60/120	75
JH-3535W(6/12)U42-T8A	3	5500-6500	220-260	3.0-3.4	700	60/120	75
JH-3535WW(6/12)U42-T8A	3	2800-3200	200-240	3.0-3.4	700	60/120	75

注:色温可定制1700-20000K, 显指可定制80/90/95, 角度可定制30/60/90/120/160
Note: CCT can be customized 1700-20000K, CRI can be customized 80/90/95,
Angle can be customized 30/60/90/120/160

陶瓷3535红黄绿蓝紫光 3535 Ceramic R,Y,G,B,V SMD led

产品规格 Product dimension

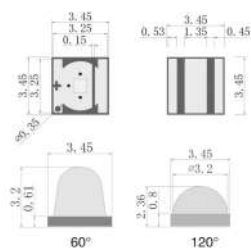

产品型号 Part No.	功率 Power(W)	波长 Wavelength(nm)	光通量 Luminous Flux(lm)	电压 Forward Voltage(V)	电流 Forward Current(mA)	角度 Angle(deg)
JH-3535R(6/12)S26-T7A	1	620-630	30-50	2.0-2.4	350	60/120
JH-3535G(6/12)S26-T7A	1	520-530	60-90	3.0-3.4	350	60/120
JH-3535B(6/12)S26-T7A	1	460-470	15-30	3.0-3.4	350	60/120
JH-3535Y(6/12)G38-T7A	1	585-595	30-60	2.0-2.4	350	60/120
JH-3535R(6/12)G42-T8A	3	620-630	80-100	2.2-2.6	700	60/120
JH-3535G(6/12)G42-T8A	3	585-595	80-90	2.2-2.6	700	60/120
JH-3535B(6/12)G45-T8A	3	520-530	160-180	3.2-3.6	700	60/120
JH-3535Y(6/12)G45-T8A	3	460-470	40-50	3.2-3.6	700	60/120
JH-3535V(6/12)G45-T8A	3	380-430	20-50	3.2-3.6	700	60/120
JH-3535V(6/12)G45-T8A-370	3	365-370	5-15	3.2-3.6	700	60/120

注:可见光波长有365-700nm
Note: Visible light has a wavelength of 365-700nm

陶瓷3535红外 3535 Ceramic IR SMD led

产品规格 Product dimension

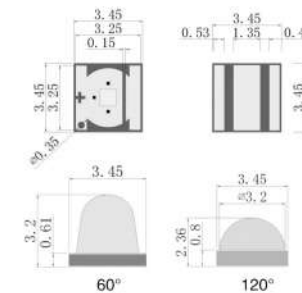

产品型号 Part No.	功率 Power(W)	波长 Wavelength(nm)	光功率 Power Dissipation(mw)	电压 Forward Voltage(V)	电流 Forward Current(mA)	角度 Angle(deg)
JH-3535IR(6/12)G30-T8A-850	1	850	100-300	1.6-2.0	350	60/120
JH-3535IR(6/12)G42-T8A-850	3	850	300-500	1.6-2.0	350	60/120

注: IR波长有700-1600nm
Note: IR wavelength is 700-1600nm

陶瓷3535双色 3535 Ceramic two-color SMD led

产品规格 Product dimension

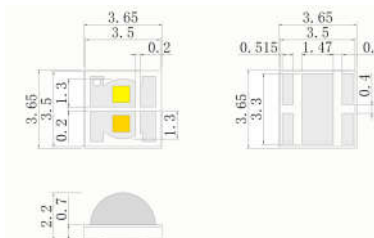

产品型号 Part No.	功率 Power(W)	波长/色温 Wavelength(nm) CCT(K)	光通量 Luminous Flux(lm)	电压 Forward Voltage(V)	电流 Forward Current(mA)	角度 Angle(deg)
JH-3535RIR12G42-T7A-660-850	6	660	80-90	2.0-2.4	700	60/120
		850	15-25	1.6-2.0	700	60/120
JH-3535WWW14U42-T7A	6	6000-8000	220-260	2.8-3.4	700	60/120
		2800-3200	200-240	2.8-3.4	700	60/120

注: 可选择定制组合
Note: Custom combinations are available

陶瓷3535RGB 3535 Ceramic RGB SMD led

产品规格 Product dimension

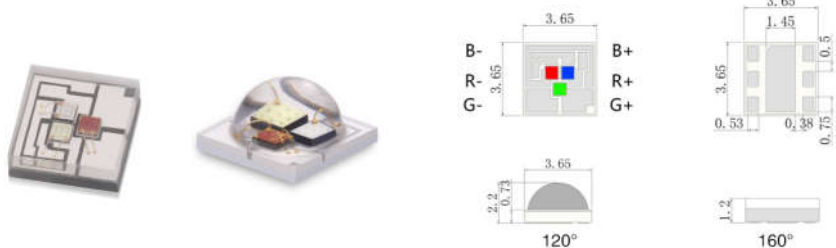

产品型号 Part No.	功率 Power(W)	波长/色温 Wavelength(nm)/ CCT(K)	光通量 Luminous Flux(lm)	电压 Forward Voltage(V)	电流 Forward Current(mA)	角度 Angle(deg)
JH-3535RGB(12/18)S20-T9A	1.5	620-630	15-25	2.0-2.4	150	120/160
		520-530	30-40	3.0-3.4	150	
		460-470	5-10	3.0-3.4	150	
JH-3535RGB(12/18)S26-T9A	3	620-630	30-50	2.0-2.4	350	120/160
		520-530	60-90	3.0-3.4	350	
		460-470	15-30	3.0-3.4	350	

注：可选择定制组合
Note: Custom combinations are available

陶瓷3535 4通道 3535 Ceramic 4-channel led

产品规格 Product dimension

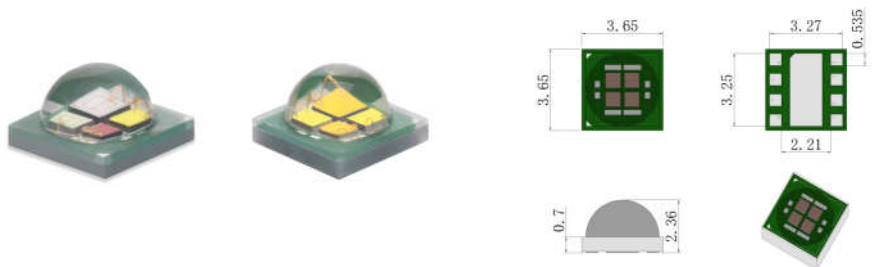

产品型号 Part No.	功率 Power(W)	波长/色温 Wavelength(nm)/ CCT(K)	光通量 Luminous Flux(lm)	电压 Forward Voltage(V)	电流 Forward Current(mA)	角度 Angle(deg)
JH-3535RGBW(12/18)S26-T9A	4	620-630	30-50	2.0-2.4	350	120/160
		520-530	60-90	3.0-3.4	350	
		460-470	15-30	3.0-3.4	350	
		6000-8000	100-120	3.0-3.4	350	
JH-3535WWW(12/18)U26-T9A	4	5500-6500	100-120	3.0-3.4	350	120/160
		2800-3200	90-110	3.0-3.4	350	

注：可选择定制组合
Note: Custom combinations are available

陶瓷5050 共晶彩光 Ceramic 5050 Eutectic colourful

产品规格 Product dimension

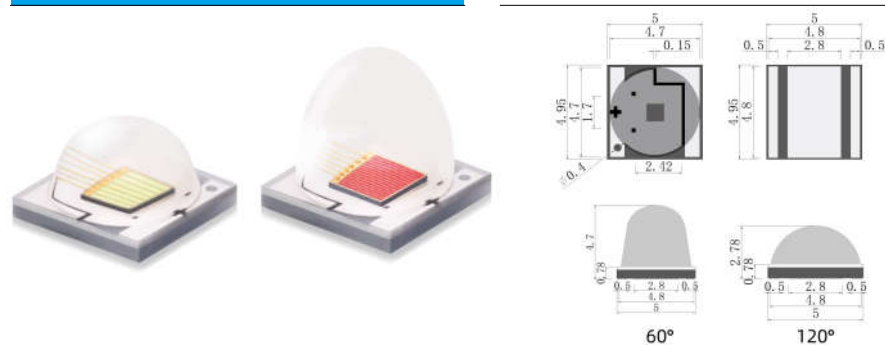

产品型号 Part No.	功率 Power(W)	波长 Wavelength(nm)	光通量 Luminous Flux(lm)	电压 Forward Voltage(V)	电流 Forward Current(mA)	角度 Angle(deg)
JH-5050R12K65-T8A	5	620-630	190-220	2.2-2.6	2000	120
JH-5050G12K65-T8A	5	520-530	350-400	3.2-3.6	2000	120
JH-5050B12K65-T8A	5	460-470	100-120	3.2-3.6	2000	120

陶瓷5050RGB 5050 Ceramic RGB SMD led

产品规格 Product dimension

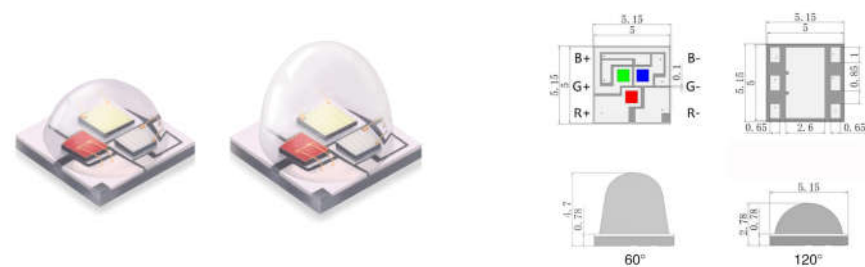

产品型号 Part No.	功率 Power(W)	波长/色温 Wavelength(nm)/ CCT(K)	光通量 Luminous Flux(lm)	电压 Forward Voltage(V)	电流 Forward Current(mA)	角度 Angle(deg)
JH-5050RGB(6/12)S26-T8A	3	620-630	30-50	2.0-2.4	350	60/120
		520-530	60-90	3.0-3.4	350	
		460-470	15-30	3.0-3.4	350	
JH-5050RGB(6/12)S39-T8A		620-630	80-100	2.0-2.4	700	60/120
		520-530	160-180	3.0-3.4	700	
		460-470	40-50	3.0-3.4	700	

注：可选择定制组合
Note: Custom combinations are available

陶瓷5050 彩光 Ceramic 5050 Colourful

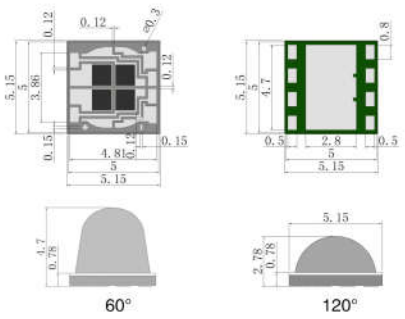
产品规格 Product dimension

产品型号 Part No.	功率 Power(W)	波长 Wavelength(nm)	光通量 Luminous Flux(lm)	电压 Forward Voltage(V)	电流 Forward Current(mA)	角度 Angle(deg)
JH-5050R(6/12)G42-T8A	3	620-630	80-100	2.2-2.6	700	60/120
JH-5050Y(6/12)G42-T8A	3	585-595	80-90	2.2-2.6	700	60/120
JH-5050G(6/12)G45-T8A	3	520-530	160-180	3.2-3.6	700	60/120
JH-5050B(6/12)G45-T8A	3	460-470	40-50	3.2-3.6	700	60/120
JH-5050V(6/12)G45-T8A	3	380-430	20-50	3.2-3.6	700	60/120
JH-5050V(6/12)G45-T8A	3	365-370	5-15	3.2-3.6	700	60/120

注：灯珠为4并，参数为单并参数。 note:Data from a single chip

陶瓷5050 红外光 Ceramic 5050 IR LED

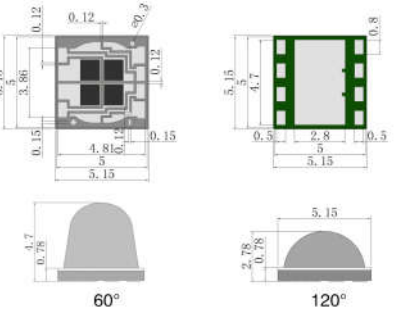
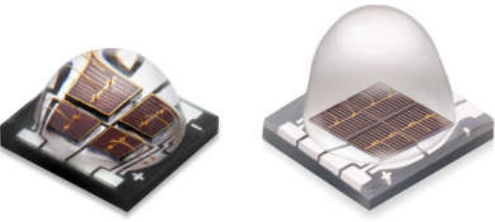
产品规格 Product dimension

产品型号 Part No.	功率 Power(W)	波长 Wavelength(nm)	光功率 Power Dissipation(mw)	电压 Forward Voltage(V)	电流 Forward Current(mA)	角度 Angle(deg)
JH-5050IR(6/12)G42-T8A-740	3	740	500-800	1.6-2.2	700	60/120
JH-5050IR(6/12)G42-T8A-810	3	810	500-800	1.6-2.2	700	60/120
JH-5050IR(6/12)G42-T8A-850	3	850	400-600	1.4-2.0	700	60/120
JH-5050IR(6/12)G42-T8A-910	3	910	300-500	1.2-1.8	700	60/120
JH-5050IR(6/12)G42-T8A-940	3	940	300-500	1.2-1.8	700	60/120

注：灯珠为4并，参数为单并参数。 note:Data from a single chip

陶瓷5050白光 5050 Ceramic white SMD led

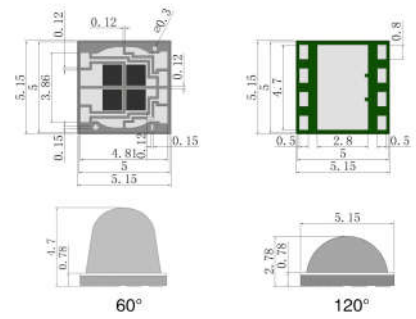
产品规格 Product dimension

产品型号 Part No.	功率 Power(W)	色温 CCT(K)	光通量 Luminous Flux(lm)	电压 Forward Voltage(V)	电流 Forward Current(mA)	角度 Angle(deg)	显色指数 CRI
JH-5050W(6/12)U42-T8A	3	5500-6500	220-260	3.0-3.4	700	60/120	75
JH-5050WW(6/12)U42-T8A	3	2800-3200	200-240	3.0-3.4	700	60/120	75

注：灯珠为4并，参数为单并参数。 note:Data from a single chip

陶瓷5050 4通道 5050 Ceramic 4-channel led

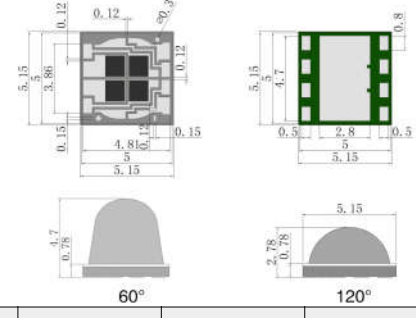
产品规格 Product dimension

产品型号 Part No.	功率 Power(W)	波长/色温 Wavelength(nm)/ CCT(K)	光通量 Luminous Flux(lm)	电压 Forward Voltage(V)	电流 Forward Current(mA)	角度 Angle(deg)
JH-5050RGBW(6/12)G45-T9A	12	620-630	80-100	2.0-2.4	700	60/120
		520-530	160-180	3.0-3.4	700	
		460-470	40-50	3.0-3.4	700	
		6000-8000	220-260	3.0-3.4	700	
JH-5050WWW(6/12)U42-T9A	12	5500-6500	220-260	3.0-3.4	700*2	60/120
		2800-3200	200-240	3.0-3.4	700*2	

 注：可选择定制组合
 Note: Custom combinations are available

大功率3550花生米白灯 high power 3550 peanut white led

产品规格 Product dimension

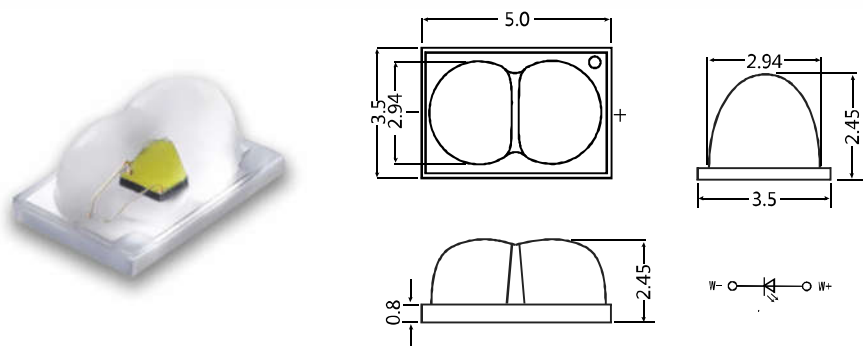

产品型号 Part No.	功率 Power(W)	色温 CCT(K)	光通量 Luminous Flux(lm)	电压 Forward Voltage(V)	电流 Forward Current(mA)	角度 Angle(deg)
JH-3550W14U27-T7A-A	1	6000-8000	100-140	3.0-3.4	350	140/90
JH-3550WW14U27-T7A	1	2800-3200	100-140	3.0-3.4	350	140/90
JH-3550W14S40-T7A-A	3	6000-8000	230-280	3.2-3.6	700	140/90
JH-3550WW14S40-T7A	3	2800-3200	230-280	3.2-3.6	700	140/90

大功率3550花生米彩光 high power 3550 peanut Colourful

产品规格 Product dimension

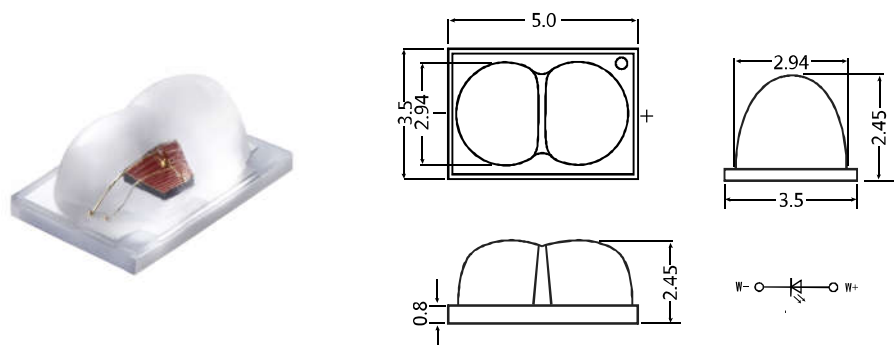

产品型号 Part No.	功率 Power(W)	波长 Wavelength(nm)	光通量 Luminous Flux(lm)	电压 Forward Voltage(V)	电流 Forward Current(mA)	角度 Angle(deg)
JH-3550R14G42-T7A	3	620-630	80-100	2.2-2.6	700	140/90
JH-3550Y14G42-T7A	3	585-595	80-90	2.2-2.6	700	140/90
JH-3550G14G45-T7A	3	520-530	160-180	3.2-3.6	700	140/90
JH-3550B14G45-T7A	3	460-470	40-50	3.2-3.6	700	140/90
JH-3550V14G45-T7A	3	380-430	20-50	3.2-3.6	700	140/90
JH-3550V14G45-T7A	3	365-370	0-5-15	3.2-3.6	700	140/90

3636陶瓷石英透镜紫 3636 Ceramic quartz lens violet led

产品规格 Product dimension

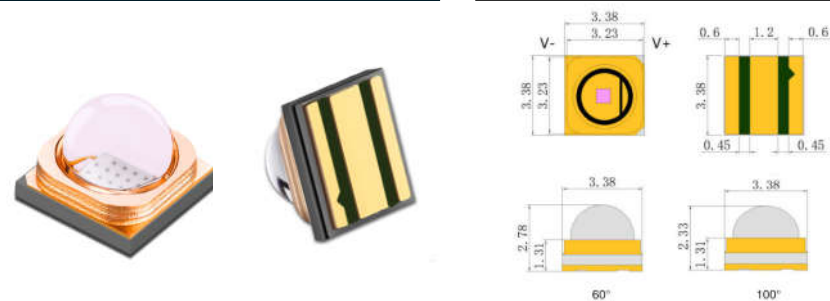

产品型号 Part No.	功率 Power(W)	波长 Wavelength(nm)	光功率 Power Dissipation(mw)	电压 Forward Voltage(V)	电流 Forward Current(mA)	角度 Angle(deg)
JH-3636V(6/10)S45-T8A -JC370	3	365-370	600-800	3.2-3.6	700	60/100
JH-3636V(6/10)S45-T8A -JC387.5	3	385-390	600-800	3.2-3.6	700	60/100
JH-3636V(6/10)S45-T8A -JC397.5	3	395-400	600-800	3.2-3.6	700	60/100

7070陶瓷石英透镜紫 7070 Ceramic quartz lens violet led

产品规格 Product dimension

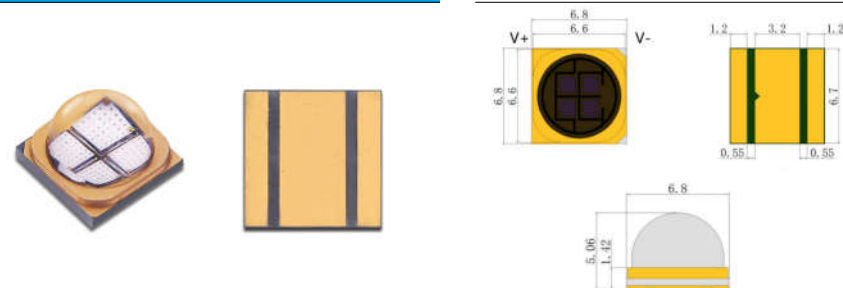

产品型号 Part No.	功率 Power(W)	波长 Wavelength(nm)	光功率 Power Dissipation(mw)	电压 Forward Voltage(V)	电流 Forward Current(mA)	角度 Angle(deg)
JH-7070V6S45-T8A -JC370	12	365-370	1100-1300	6.0-7.0	1400	60/100
JH-7070V6S45-T8A -JC387.5	12	385-390	1100-1300	6.0-7.0	1400	60/100
JH-7070V6S45-T8A -JC397.5	12	395-400	1100-1300	6.0-7.0	1400	60/100

5060陶瓷大功率RGBW 5060 ceramic high power RGBW

产品规格 Product dimension

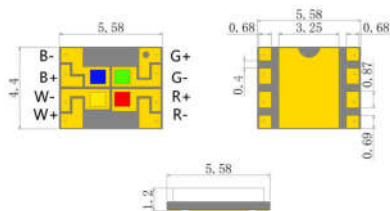
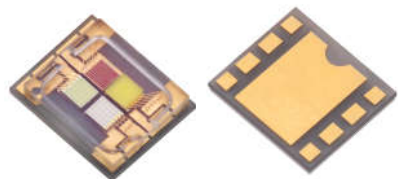

产品型号 Part No.	功率 Power(W)	波长/色温 Wavelength(nm)/ CCT(K)	光通量 Luminous Flux(lm)	电压 Forward Voltage(V)	电流 Forward Current(mA)	角度 Angle(deg)
JH-5060RGBW12S47-T8A -J455	20	620-630	120-140	2.0-2.4	1500	120
		520-530	250-300	3.0-3.4	1500	
		450-455	60-80	3.0-3.4	1500	
		6000-8000	300-350	3.0-3.4	1500	

3535陶瓷倒装白光 3535 ceramic flip white SMD LED

产品规格 Product dimension

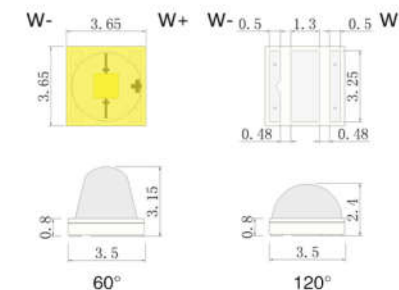

产品型号 Part No.	功率 Power(W)	色温 CCT(K)	光通量 Luminous Flux(lm)	电压 Forward Voltage(V)	电流 Forward Current(mA)	角度 Angle(deg)
JH-3636W(6/12)JC45-T7A -DZ	3	6000-8000	280-300	3.0-3.6	700	60/120
JH-3535W(6/12)GE55-T8A-A	5	6000-8000	600-800	3.0-3.6	1500	60/120
JH-3537W(6/12)GE76-T8A -DZ	10	6000-8000	900-1100	3.0-3.6	3000	60/120

6065陶瓷大功率4通道 6065 Ceramic 4-channel led

产品规格 Product dimension

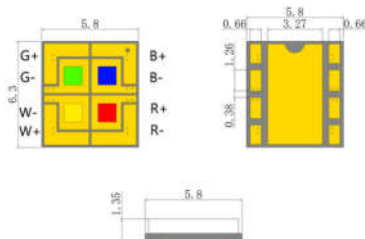
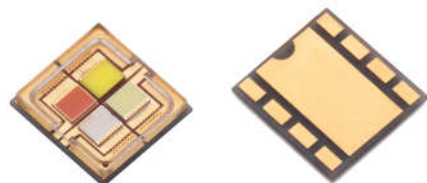

产品型号 Part No.	功率 Power(W)	波长/色温 Wavelength(nm)/ CCT(K)	光通量 Luminous Flux(lm)	电压 Forward Voltage(V)	电流 Forward Current(mA)	角度 Angle(deg)
JH-6065RGBW12S63-T8A -J455	40	620-630	160-200	2.2-2.6	1000-4000	120
		520-530	400-880	3.2-3.8	1000-4000	
		450-455	80-190	3.2-3.8	1000-4000	
		6000-8000	550-1050	3.2-3.8	1000-4000	

7070陶瓷石英透镜 7070 Ceramic quartz lens led

产品规格 Product dimension

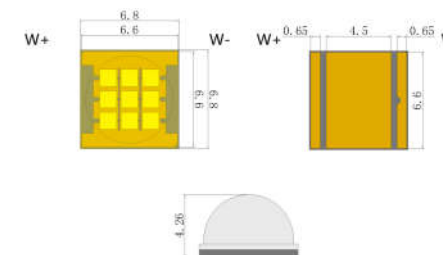
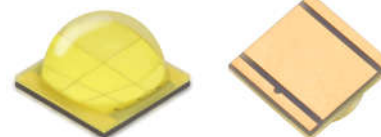

产品型号 Part No.	功率 Power(W)	色温 CCT(K)	光通量 Luminous Flux(lm)	电压 Forward Voltage(V)	电流 Forward Current(mA)	角度 Angle(deg)
JH-7070W12JC55-T8A -DZ	50	6000-8000	5500-6500	9-11V	6000	120

SMD贴片系列 SMD patch series

贴片2835单色 SMD 2835 Single Color

产品规格 Product dimension

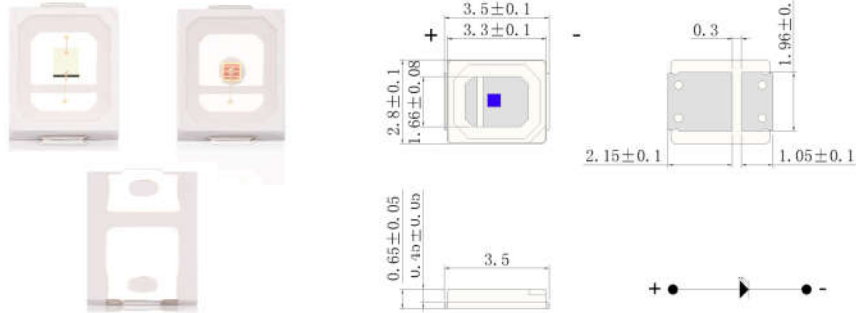

产品型号 Part No.	功率 Power(W)	波长 Wavelength(nm)	光通量 Luminous Flux(lm)	电压 Forward Voltage(V)	电流 Forward Current(mA)	角度 Angle(deg)
JH-2835G12F20-T10A	0.5	520-525	30-40	2.8-3.2	150	120
JH-2835R12D20-T10A	0.5	620-625	15-25	2.0-2.4	150	120
JH-2835B12F20-T10A	0.5	455-465	5-10	2.8-3.2	150	120
JH-2835Y12G20-T10A	0.5	590-595	15-25	2.0-2.4	150	120
JH-2835V12G20-T10A	0.5	365-440	1-10	3.0-3.4	150	120

注:可定制波长365-1000nm
Note: Customizable wavelength 365-1000nm

贴片2835双色温 SMD 2835 Dual Color Temperature

产品规格 Product dimension

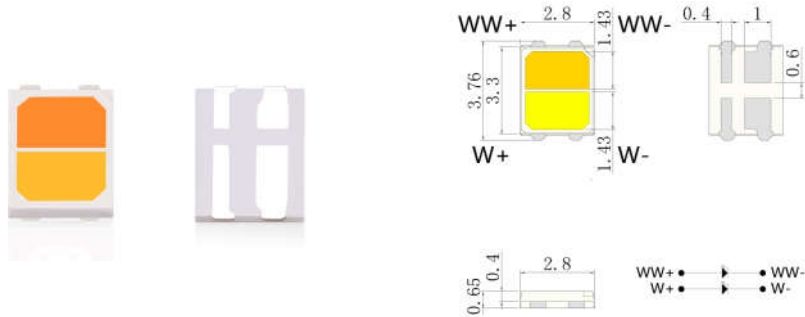

产品型号 Part No.	功率 Power(W)	色温 CCT(K)	光通量 Luminous Flux(lm)	电压 Forward Voltage(V)	电流 Forward Current(mA)	角度 Angle(deg)	显色指数 CRI
JH-2835WWW12P18-T14A	0.5	5000-6000	30-50	2.8-3.2	150	120	90
	0.5	2800-3200	30-50	2.8-3.2	150	120	90

注:可选择定制组合
Note: Custom combinations are available

贴片3030双色温 SMD 3030 Dual Color Temperature

产品规格 Product dimension

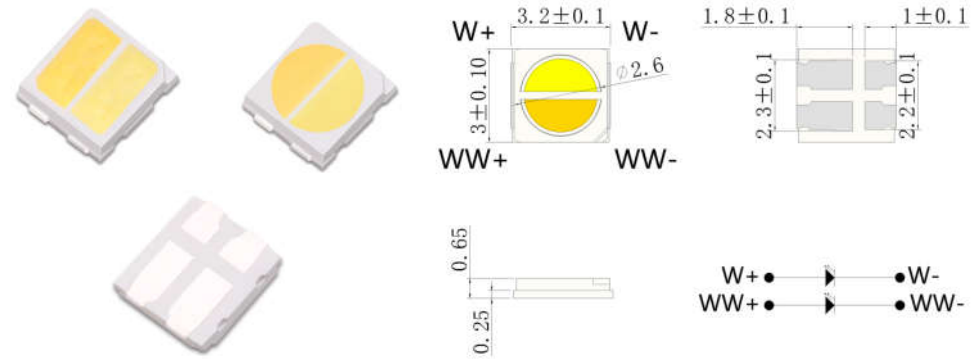

产品型号 Part No.	功率 Power(W)	色温 CCT(K)	光通量 Luminous Flux(lm)	电压 Forward Voltage(V)	电流 Forward Current(mA)	角度 Angle(deg)	显色指数 CRI
JH-3030WWW12P18-T14A	0.5	5000-6000	30-50	2.8-3.2	150	120	90
	0.5	2800-3200	30-50	2.8-3.2	150	120	90

注:可选择定制组合
Note: Custom combinations are available

贴片3030 RGB SMD 3030 RGB

产品规格 Product dimension

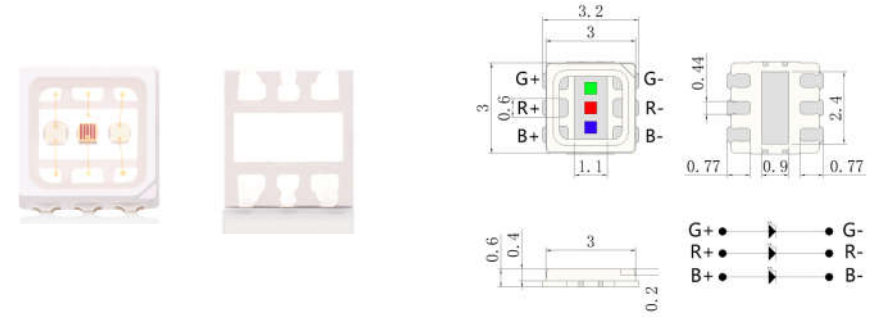

产品型号 Part No.	功率 Power(W)	色温 CCT(K)	光通量 Luminous Flux(lm)	电压 Forward Voltage(V)	电流 Forward Current(mA)	角度 Angle(deg)
JH-3030GRB12J20-C2A	0.5	520-525	30-40	2.8-3.2	150	120
	0.5	620-625	15-25	2.0-2.4	150	
	0.5	455-465	5-10	2.8-3.2	150	

注:可选择定制组合
Note: Custom combinations are available

贴片5054双色温 SMD 5054 Dual color temperature

产品规格 Product dimension

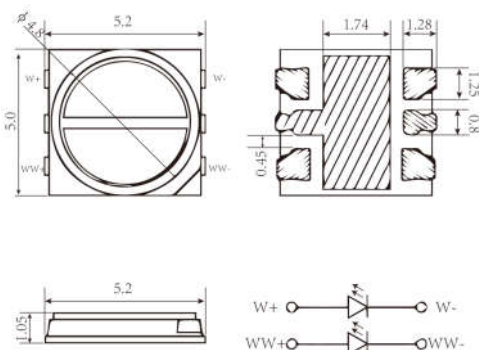

产品型号 Part No.	功率 Power(W)	色温 CCT(K)	光通量 Luminous Flux(lm)	电压 Forward Voltage(V)	电流 Forward Current(mA)	角度 Angle(deg)	显色指数 CRI
JH-5054WWW12S35-T8A	0.5	5000-6000	40-60	3.0-3.4	150	120	95-98
	0.5	2800-3200	40-50	3.0-3.4	150	120	95-98

贴片5054 RGB SMD 5054 RGB

产品规格 Product dimension

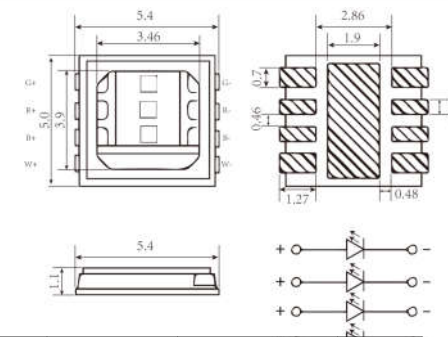
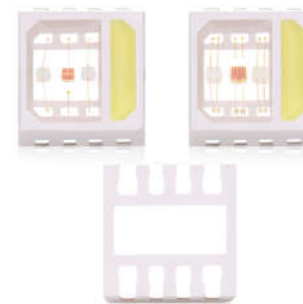

产品型号 Part No.	功率 Power(W)	波长 Wavelength(nm)	光通量 Luminous Flux(lm)	电压 Forward Voltage(V)	电流 Forward Current(mA)	角度 Angle(deg)
JH-5054GRBW12J20-T11A	0.5	520-525	30-40	3.0-3.4	150	140
	0.5	620-625	15-25	2.2-2.6	150	
	0.5	460-465	5-10	3.0-3.4	150	
	0.5	6000-6500K	40-60	3.0-3.4	150	
JH-5054GRBW12J31-T11A	1	520-525	60-80	3.0-3.4	350	140
	1	620-625	30-50	2.2-2.6	350	
	1	460-465	10-20	3.0-3.4	350	
	1	6000-6500K	120-140	3.0-3.4	350	

贴片5054 RGB SMD 5054 RGB

产品规格 Product dimension

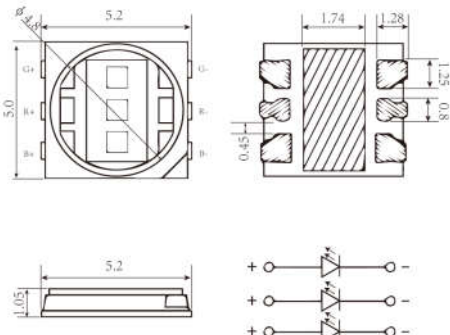
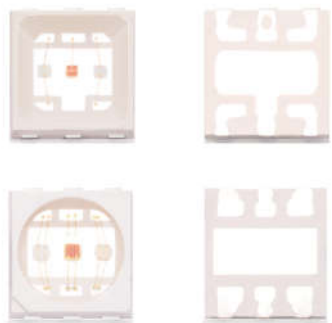

产品型号 Part No.	功率 Power(W)	波长 Wavelength(nm)	光通量 Luminous Flux(lm)	电压 Forward Voltage(V)	电流 Forward Current(mA)	角度 Angle(deg)
JH-5054GRB12S20-T11A	0.5	520-525	30-40	3.0-3.4	150	120
	0.5	620-625	15-25	2.2-2.6	150	
	0.5	455-465	5-10	3.0-3.4	150	
JH-5054GRB12J31-T11A-Y	1	520-525	60-80	3.0-3.4	350	120
	1	620-625	30-50	2.2-2.6	350	
	1	455-465	10-25	3.0-3.4	350	

贴片6064五色灯珠 SMD 6064 Five colour led

产品规格 Product dimension

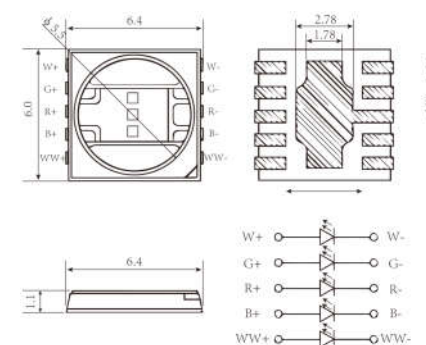
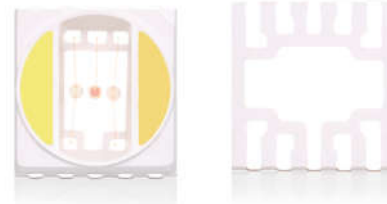

产品型号 Part No.	功率 Power(W)	波长 Wavelength(nm)	光通量 Luminous Flux(lm)	电压 Forward Voltage(V)	电流 Forward Current(mA)	角度 Angle(deg)
JH-6064WGRBWW12F20-T13A	0.5	6000-6500K	40-60	3.0-3.4	150	120
	0.5	520-525	30-40	3.0-3.4	150	
	0.5	620-625	15-25	2.2-2.6	150	
	0.5	460-465	5-10	3.0-3.4	150	
	0.5	2800-3200K	40-60	3.0-3.4	150	
	0.5	6000-6500K	40-60	3.0-3.4	150	

贴片5050 EMD 白光 SMD 5050 EMC White led

产品规格 Product dimension

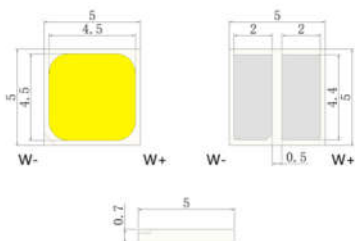
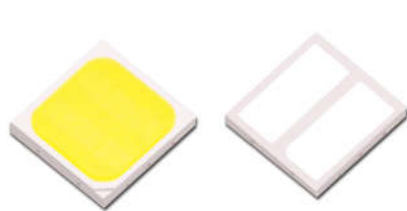

产品型号 Part No.	功率 Power(W)	色温 CCT(K)	光通量 Luminous Flux(lm)	电压 Forward Voltage(V)	电流 Forward Current(mA)	角度 Angle(deg)	显色指数 CRI
JH-5050WW12JC2639-C5A	5	2800-3200	600-700	5.5-6.5	700	120	80
JH-5050W12JC2639-C5A	5	6000-8000	700-800	5.5-6.5	700	120	80

注:色温可定制1700-20000K,显指可定制80/90/95
Note: CCT can be customized 1700-20000K,CRI can be customized 80/90/95

贴片3030 3W 彩光 SMD 3030 3W Colourful

产品规格 Product dimension

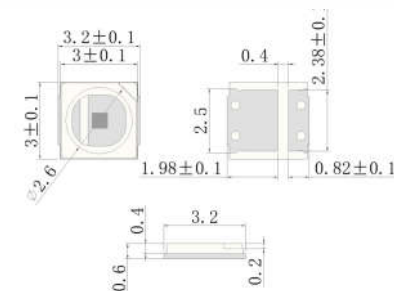

产品型号 Part No.	功率 Power(W)	波长 Wavelength(nm)	光通量 Luminous Flux(lm)	电压 Forward Voltage(V)	电流 Forward Current(mA)	角度 Angle(deg)
JH-3030R12G42-C3A	3	620-630	80-100	2.2-2.6	700	120
JH-3030Y12G42-C3A	3	585-595	80-90	2.2-2.6	700	120
JH-3030G12G45-C3A	3	520-530	160-180	3.2-3.6	700	120
JH-3030B12G45-C3A	3	460-470	40-50	3.2-3.6	700	120
JH-3030V12G45-C3A	3	380-430	20-50	3.2-3.6	700	120
JH-3030V12G45-C3A-370	3	365-370	5-15	3.2-3.6	700	120

注:可见光波长有365-700nm
Note: Visible light has a wavelength of 365-700nm

贴片7070 EMC 白光 SMD 7070 EMC White

产品规格 Product dimension

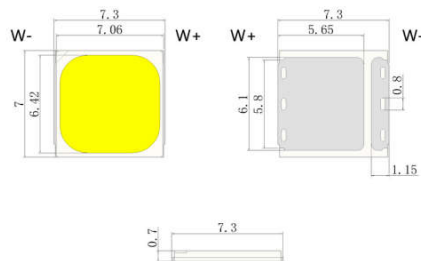

产品型号 Part No.	功率 Power(W)	色温 CCT(K)	光通量 Luminous Flux(lm)	电压 Forward Voltage(V)	电流 Forward Current(mA)	角度 Angle(deg)	显色指数 CRI
JH-7070WW12JC2639-C2A	10	2800-3200	1300-1500	8-9	1000	120	80
JH-7070W12JC2639-C2A	10	6000-8000	1500-1700	8-9	1000	120	80

注:色温可定制1700-20000K,显指可定制80/90/95
Note: CCT can be customized 1700-20000K,CRI can be customized 80/90/95

贴片5054 田字四通道 SMD 5054 Square Four Channel

产品规格 Product dimension

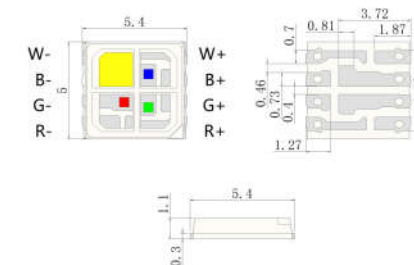
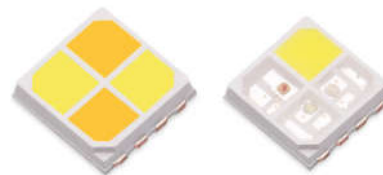

产品型号 Part No.	功率 Power(W)	波长/色温 Wavelength(nm)/ CCT(K)	光通量 Luminous Flux(lm)	电压 Forward Voltage(V)	电流 Forward Current(mA)	角度 Angle(deg)
JH-5050RGBW12P18-T10A-FK	2	620-630	15-25	2.0-2.4	150	120
		520-530	30-40	3.0-3.4	150	
		460-470	5-10	3.0-3.4	150	
		6000-8000	40-60	3.0-3.4	150	
JH-5054WWW12P18-T10A-FK	2	5500-6500	40-60	3.0-3.4	150*2	120
		2800-3200	40-60	3.0-3.4	150*2	

注:可选择定制组合
Note: Custom combinations are available

仿流明系列 High power series

大功率1W-3W白灯 High power 1W-3W white led

产品规格 Product dimension

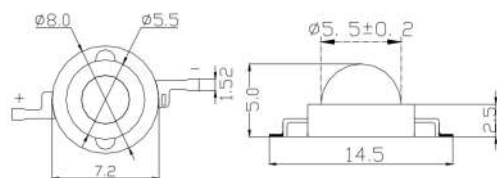

产品型号 Part No.	功率 Power(W)	色温 CCT(K)	光通量 Luminous Flux(lm)	电压 Forward Voltage(V)	电流 Forward Current(mA)	角度 Angle(deg)	显色指数 CRI
JH-1W14P35-T4A	1	6000-8000	100-120	2.8-3.2	350	140	70
JH-1WW14P35-T4A	1	2800-3200	90-110	2.8-3.2	350	140	70
JH-3W14P45-T4A	3	6000-8000	220-260	2.8-3.2	700	140	70
JH-3WW14P45-T4A	3	2800-3200	200-240	2.8-3.2	700	140	70
JH-5W14P45-T2A	5	6000-8000	400-450	2.8-3.2	1400	140	70
JH-5WW14P45-T2A	5	2800-3200	380-430	2.8-3.2	1400	140	70

注:色温可定制1700-20000K, 显指可定制80/90/95

Note: CCT can be customized 1700-20000K, CRI can be customized 80/90/95

大功率1W-3W红黄绿蓝紫灯 High power 1W-3W red, yellow, green, blue, violet led

产品规格 Product dimension

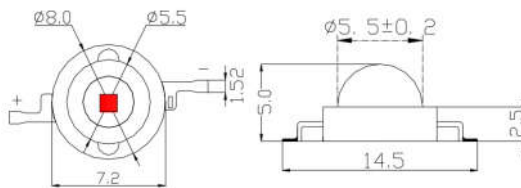

产品型号 Part No.	功率 Power(W)	波长 Wavelength(nm)	光通量 Luminous Flux(lm)	电压 Forward Voltage(V)	电流 Forward Current(mA)	角度 Angle(deg)
JH-1R14G30-T2A	1	620-630	40-50	2.0-2.4	350	140
JH-1Y14G30-T2A	1	585-595	40-50	2.0-2.4	350	140
JH-1B14F40-T2A	1	460-470	15-25	2.8-3.4	350	140
JH-1G14F40-T2A	1	520-530	60-70	2.8-3.4	350	140
JH-1V14G40-T2A	1	390-420	10-20	2.8-3.4	350	140
JH-3R14G42-T2A	3	620-630	80-100	2.0-2.4	700	140
JH-3Y14G42-T2A	3	585-595	80-90	2.0-2.4	700	140
JH-3B14G45-T2A	3	460-470	30-40	2.8-3.4	700	140
JH-3G14G45-T2A	3	520-530	160-180	2.8-3.4	700	140
JH-3V14G45-T2A	3	390-420	20-40	2.8-3.4	700	140
JH-3V14G45-T2A-365	3	365-370	5-10	2.8-3.4	700	140

注:可见光波长有365-700nm

Note: Visible light has a wavelength of 365-700nm

大功率3W红外黑支架 High power 3W IR with black frame

产品规格 Product dimension

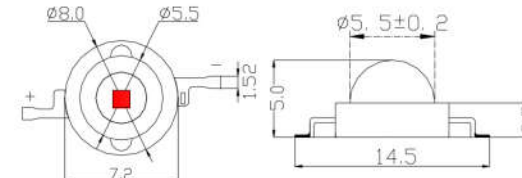

产品型号 Part No.	功率 Power(W)	波长 Wavelength(nm)	光功率 Light power (mW)	电压 Forward Voltage(V)	电流 Forward Current(mA)	角度 Angle(deg)
JH-3IR6G42-T3A-M740	3	740	300-500	1.6-2.0	700	60
JH-3IR14G42-T3A-M740	3	740	300-500	1.6-2.0	700	140
JH-3IR6G42-T3A-M850	3	850	300-500	1.6-2.0	700	60
JH-3IR14G42-T3A-M850	3	850	300-500	1.6-2.0	700	140
JH-3IR6G42-T3A-M940	3	940	300-500	1.6-2.0	700	60
JH-3IR14G42-T3A-M940	3	940	300-500	1.6-2.0	700	140

注: IR波长有700-1600nm

Note: IR wavelength is 700-1600nm

大功率4脚RGB High power 4pins RGB

产品规格 Product dimension

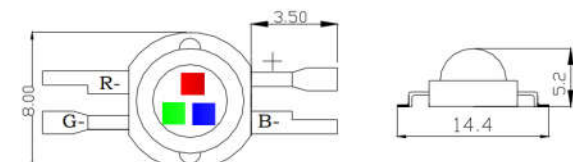

Unit:mm
tolerance: ±0.2

产品型号 Part No.	功率 Power(W)	波长 Wavelength(nm)	光通量 Luminous Flux(lm)	电压 Forward Voltage(V)	电流 Forward Current(mA)	角度 Angle(deg)
JH-1RGB14F39-F2	3	620-630	40-50	2.0-2.4	350	140
		520-530	60-70	3.0-3.4	350	140
		460-470	15-25	3.0-3.4	350	140
JH-9RGB14G45-F2	9	620-630	70-90	2.2-2.6	700	140
		520-530	140-160	3.2-3.6	700	140
		460-470	30-50	3.2-3.6	700	140

大功率4脚双色 High power 4PINS two-color

产品规格 Product dimension

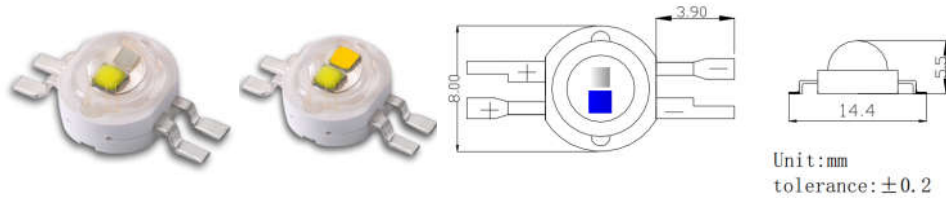

产品型号 Part No.	功率 Power(W)	波长/色温 Wavelength(nm) CCT(K)	光通量 Luminous Flux(lm)	电压 Forward Voltage(V)	电流 Forward Current(mA)	角度 Angle(deg)
JH-1WB14G30-F2A-M	2	6000-8000K	80-90	2.8-3.4	700	140
		460-470nm	15-25	2.8-3.4	700	140
JH-3WWW14P45-F2A-M	6	6000-8000	220-260	2.8-3.4	700	140
		2800-3200	200-240	2.8-3.4	700	140

大功率8脚RGBW High power 8pins RGBW

产品规格 Product dimension

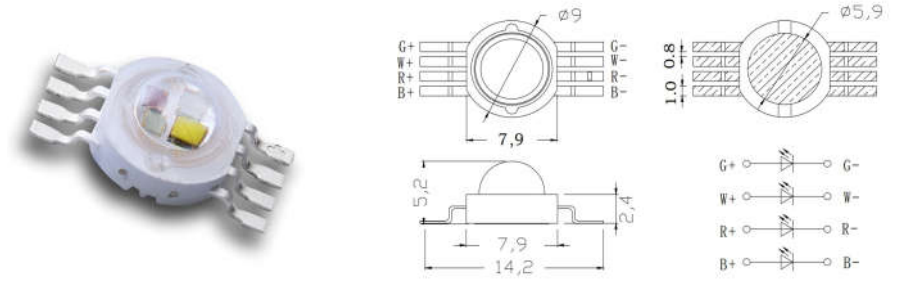

产品型号 Part No.	功率 Power(W)	波长/色温 Wavelength(nm) CCT(K)	光通量 Luminous Flux(lm)	电压 Forward Voltage(V)	电流 Forward Current(mA)	角度 Angle(deg)
JH-4ZRGBW14F39-E2	4	620-630	40-50	2.8-3.4	350	140
		520-530	60-70	2.8-3.4	350	140
		460-470	15-25	2.8-3.4	350	140
		6000-8000	100-120	2.8-3.4	350	140
JH-12RGBW14G45-E2	12	620-630	70-90	2.8-3.4	700	140
		520-530	140-160	2.8-3.4	700	140
		460-470	30-50	2.8-3.4	700	140
		6000-8000	220-260	2.8-3.4	700	140

大功率6脚RGB High power 6pins RGB

产品规格 Product dimension

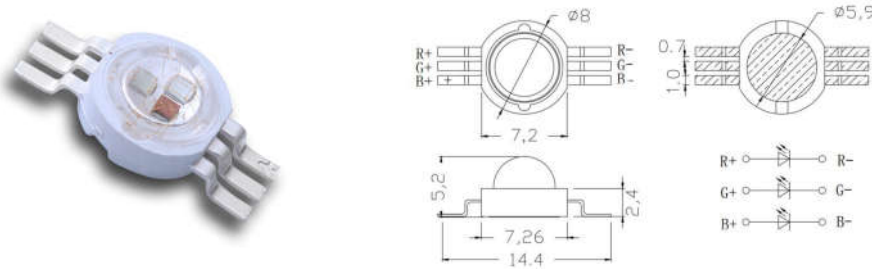

产品型号 Part No.	功率 Power(W)	波长 Wavelength(nm)	光通量 Luminous Flux(lm)	电压 Forward Voltage(V)	电流 Forward Current(mA)	角度 Angle(deg)
JH-1RGB14F39-S2	3	620-630	40-50	2.0-2.4	350	140
		520-530	40-70	3.0-3.4	350	140
		460-470	15-25	3.0-3.4	350	140
JH-9RGB14G45-S2	9	620-630	70-90	2.2-2.6	700	140
		520-530	140-160	3.2-3.6	700	140
		460-470	30-50	3.2-3.6	700	140

大功率10脚RGBWY High power 10pins RGBWY

产品规格 Product dimension

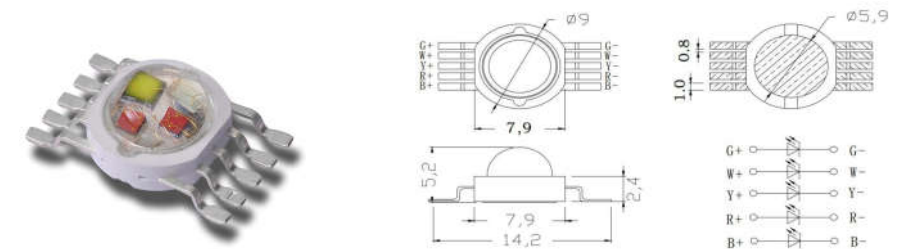

产品型号 Part No.	功率 Power(W)	波长/色温 Wavelength(nm) CCT(K)	光通量 Luminous Flux(lm)	电压 Forward Voltage(V)	电流 Forward Current(mA)	角度 Angle(deg)
JH-15ZRGBWZY14G45-E2A	15	620-630	70-90	2.0-2.4	700	140
		520-530	140-160	2.8-3.4	700	140
		460-470	30-50	2.8-3.4	700	140
		6000-8000	220-260	2.8-3.4	700	140
		585-595	60-80	2.0-2.4	700	140

12W RGBW R9C COB 12W RGBW(R9C Type Frame)

产品规格 Product dimension

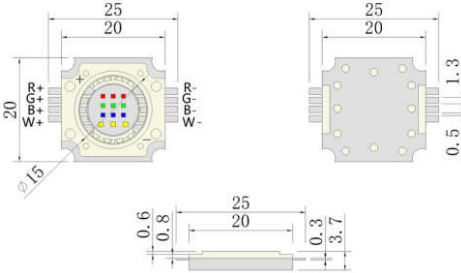

产品型号 Part No.	功率 Power(W)	波长/色温 Wavelength(nm) CCT(K)	光通量 Luminous Flux(lm)	电压 Forward Voltage(V)	电流 Forward Current(mA)	角度 Angle(deg)
JH-12RGBW14F39-R9C	12	620-630	120-150	6-7	350	140
		520-530	180-210	9-10	350	140
		460-470	45-75	9-10	350	140
		6000-8000	240-300	9-10	350	140
JH-12RGBW14G45-R9C	12	620-630	150-180	6-7	700	140
		520-530	240-270	9-10	700	140
		460-470	75-105	9-10	700	140
		6000-8000	300-360	9-10	700	140

18-30W RGB J1C COB 18-30W RGB(R9C Type Frame)

产品规格 Product dimension

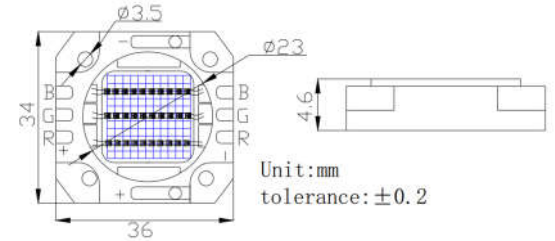

产品型号 Part No.	功率 Power(W)	波长 Wavelength(nm)	光通量 Luminous Flux(lm)	电压 Forward Voltage(V)	电流 Forward Current(mA)	角度 Angle(deg)
JH-18RGB14G45-J1C	18	620-625	200-240	12-14	350	140
		520-525	500-600	18-20	350	140
		460-465	90-150	18-20	350	140
JH-30RGB14G45-J1C	30	620-625	450-550	20-24	350	140
		520-525	700-900	30-32	350	140
		460-465	250-350	32-34	350	140

15W RGBWWW R9C COB 15W RGBWWW(R9C Type Frame)

产品规格 Product dimension

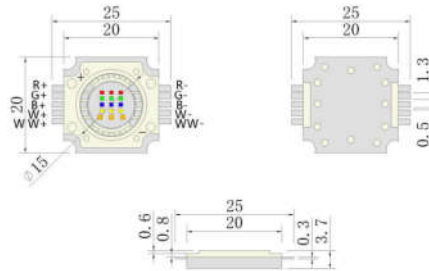

产品型号 Part No.	功率 Power(W)	波长/色温 Wavelength(nm) CCT(K)	光通量 Luminous Flux(lm)	电压 Forward Voltage(V)	电流 Forward Current(mA)	角度 Angle(deg)
JH-15RGBWWW14F39-R9C	15	620-630	120-150	6-7	350	140
		520-530	180-210	9-10	350	140
		460-470	45-75	9-10	350	140
		6000-8000	240-300	9-10	350	140
		2800-3200	220-280	9-10	350	140
JH-15RGBWWW14G45-R9C	15	620-630	150-180	6-7	350	140
		520-530	240-270	9-10	350	140
		460-470	75-105	9-10	350	140
		6000-8000	300-360	9-10	350	140
		2800-3200	220-280	9-10	350	140

60-90W RGB Z3C COB 60-90W RGB(Z3C Type Frame)

产品规格 Product dimension

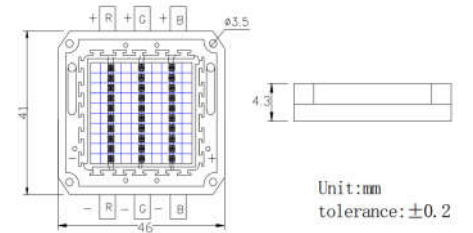

产品型号 Part No.	功率 Power(W)	波长 Wavelength(nm)	光通量 Luminous Flux(lm)	电压 Forward Voltage(V)	电流 Forward Current(mA)	角度 Angle(deg)
JH-60RGB14G45-Z3C	60	620-625	900-1100	20-24	700	140
		520-525	1400-1800	30-32	700	140
		460-465	500-700	32-34	700	140
JH-90RGB14G45-Z3C	90	620-625	1350-1650	20-24	1050	140
		520-525	2100-2700	30-32	1050	140
		460-465	750-1050	32-34	1050	140

40-120W RGBW Z1C COB 40-120W RGBW(Z1C Type Frame)

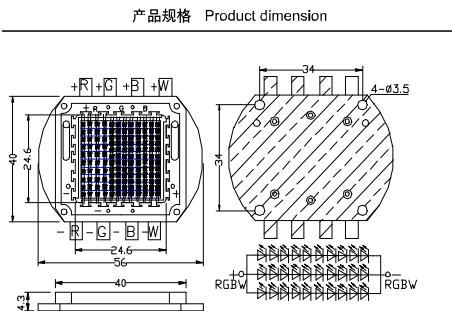

产品型号 Part No.	功率 Power(W)	波长/色温 Wavelength(nm) CCT(K)	光通量 Luminous Flux(lm)	电压 Forward Voltage(V)	电流 Forward Current(mA)	角度 Angle(deg)
JH-40RGBW14G45-Z1C	40	620-630	400-600	10-12	700	140
		520-530	800-1000	14-16	700	140
		460-470	250-350	14-16	700	140
		6000-8000	1000-1200	14-16	700	140
JH-120RGBW14G45-Z1C	120	620-630	1200-1800	20-24	1050	140
		520-530	2400-3000	30-24	1050	140
		460-470	75-1050	30-34	1050	140
		6000-8000	3000-4500	30-34	1050	140

5-100W 白光 COB COB 5-100W White

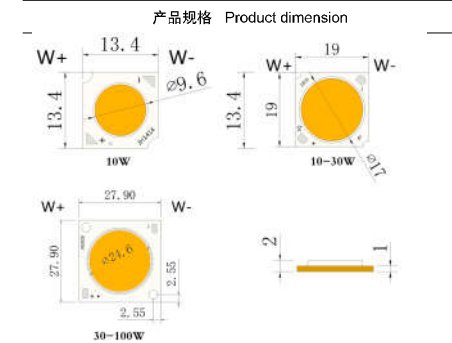
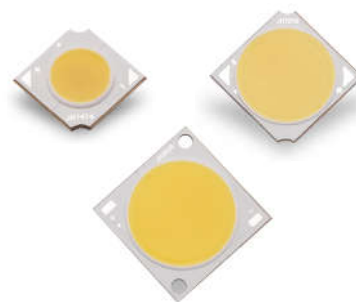

产品型号 Part No.	功率 Power(W)	色温 CCT(K)	光通量 Luminous Flux(lm)	电压 Forward Voltage(V)	电流 Forward Current(mA)	角度 Angle(deg)	显色指数 CRI
JH-5(W/WW)14JC2639-Y6C	5	6000-7000	600-700	30-34	150	140	70+
JH-10(W/WW)14JC2639-Y6C	10	6000-7000	1200-1400	30-34	300	140	70+
JH-30(W/WW)14JC2639-J6C	30	6000-7000	3600-4200	30-34	900	140	70+
JH-50(W/WW)14JC2639-J4C	50	6000-7000	6000-7000	30-34	1500	140	70+
JH-100(W/WW)14JC2639-J4C	100	6000-7000	12000-14000	30-34	3000	140	70+

注:色温可定制1700-20000K,显指可定制80/90/95,功率可定制5-100W
Note: CCT can be customized 1700-20000K, CRI can be customized 80/90/95, Power can be customized 5-100W

41W RGBWW HMC COB 41W RGBWW(HMC Type Frame)

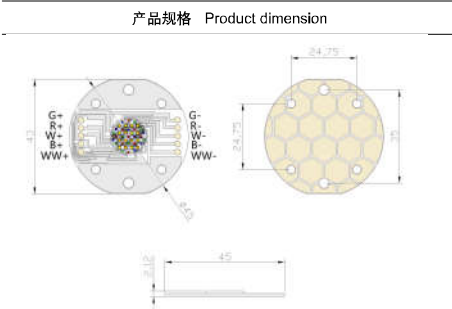

产品型号 Part No.	功率 Power(W)	波长/色温 Wavelength(nm) CCT(K)	光通量 Luminous Flux(lm)	电压 Forward Voltage(V)	电流 Forward Current(mA)	角度 Angle(deg)
JH-41GRWBWW18S38-HMC	41	620-630	300-400	24-26	400	140
		520-530	700-800	24-26	400	140
		460-470	250-350	24-26	400	140
		6000-8000	1800-2200	24-26	700	140
		2800-3200	1500-2000	24-26	700	140

双色温 COB Two color temperature COB

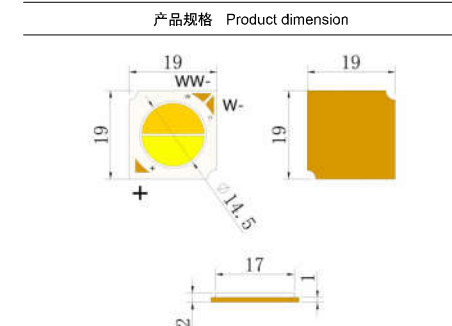

产品型号 Part No.	功率 Power(W)	色温 CCT(K)	光通量 Luminous Flux(lm)	电压 Forward Voltage(V)	电流 Forward Current(mA)	角度 Angle(deg)	显色指数 CRI
JH-16WWW12JC2240-J15C	8	5000-6000	1000-1500	12-14	750	120	90+
	8	2800-3200	900-1300	12-14	750	120	90+

特殊光谱系列 Special spectral series

似太阳光谱 COB Sunlight Full Spectrum Spectrum COB

产品规格 Product dimension

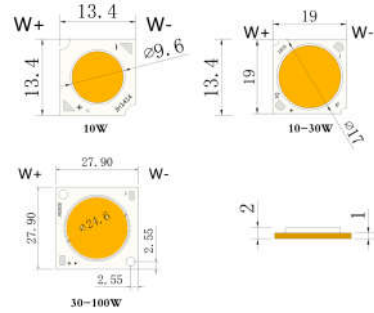
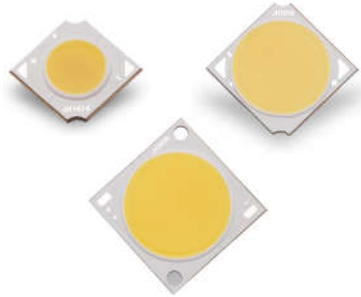

光谱图 Spectrum

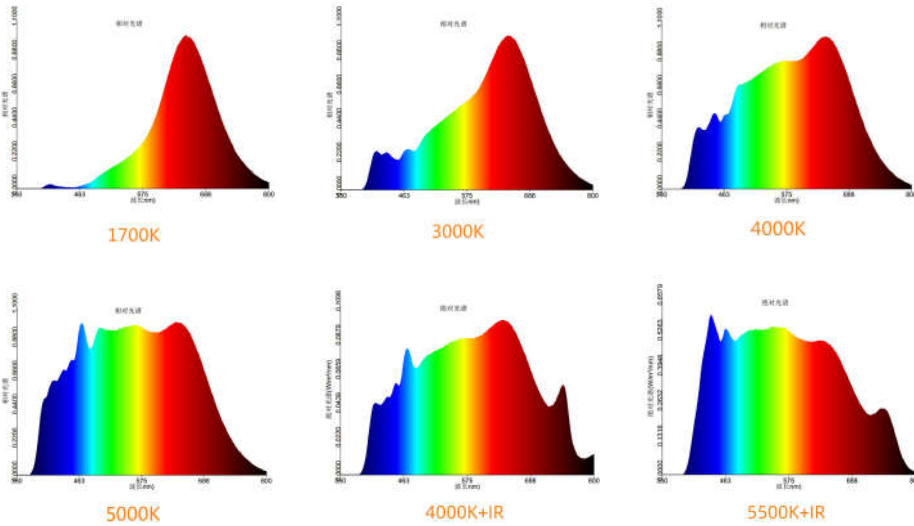

产品型号 Part No.	功率 Power(W)	色温 CCT(K)	光通量 Luminous Flux(lm)	电压 Forward Voltage(V)	电流 Forward Current(mA)	角度 Angle(deg)	显色指数 CRI
JH-5(WWW)BVG14G24-Y6C	5	1700-5000	300-500	34-38	150	140	95-99
JH-10(WWW)BVG14G24-Y6C	10	1700-5000	500-700	34-38	300	140	95-99
JH-30(WWW)BVG14G45-J6C	30	1700-5000	2000-3000	30-34	1050	140	95-99
JH-50(WWW)BVG14G45-J4C	50	1700-5000	3500-4500	30-34	1750	140	95-99
JH-100(WWW)BVG14G45-J4C	100	1700-5000	8000-9000	30-34	3500	140	95-99

注:色温可定制1700-20000K,功率可定制5-500W,5W递增
Note: CCT can be customized 1700-20000K, Power can be customized 5-500W, 5W increments

光谱图

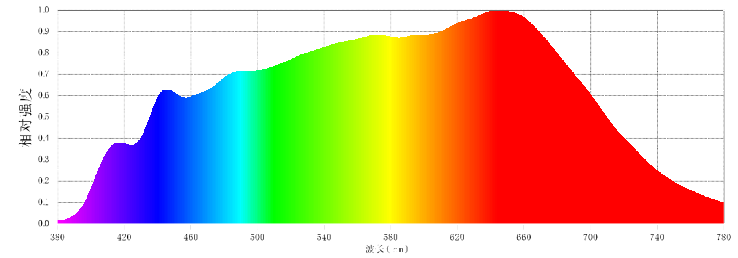

光色度参数

CIE _x	0.3717
CIE _y	0.3730
CIE _{u'}	0.2208
CIE _{v'}	0.4986
相关色温 CCT	4222 K
照体线距离 Duv	0.0010
显色指数 Ra (R1~R8)	99
显色指数 Re (R1~R15)	99
光色品质 CQS	99
TLCI (Qa)	100
GAI	81
TM -30-15 Rf	98
TM -30-15 Rg	100
照度	9,280 lux
照烛光	862.2 fc
光子通量密度	161.30 μmol/m ² s
峰值波长 (λp)	645 nm
主波长 (λD)	578 nm
色纯度	20%
暗明视觉比	1.9

CIE 1931

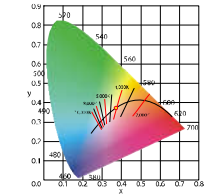

CIE 1976

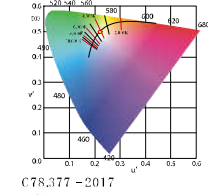

78.377-2017

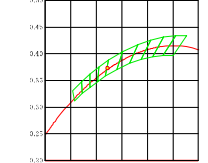

IEC-SD CM

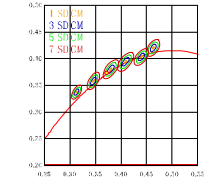

显色指数 Re (R1~R15)

R1	100	R6	99	R11	99
R2	100	R7	99	R12	97
R3	99	R8	99	R13	99
R4	99	R9	97	R14	99
R5	100	R10	99	R15	99

TM -30-15

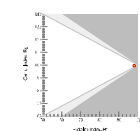
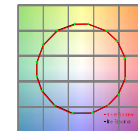

全光谱贴片 Full spectrum SMD



2835



3030



5050

光谱图 Spectrum

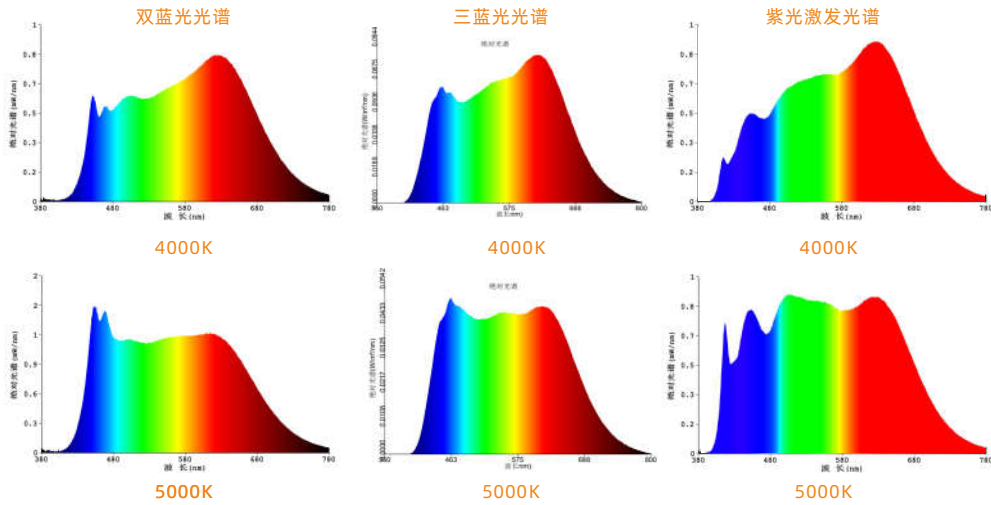

双蓝光光谱参考

三蓝光光谱参考

产品型号 Part No.	功率 Power(W)	色温 CCT(K)	光通量 Luminous Flux(lm)	电压 Forward Voltage(V)	电流 Forward Current(mA)	角度 Angle(deg)	显色指数 CRI
JH-2835WB12P18-T10A	0.5-1	2800-6000	80-90	6.0-6.4	150	120	90-95
JH-3030WBB12ZW33-T10A	0.5-1.5	2800-6000	140-160	9.0-9.4	150	120	95-99
JH-5050VBW12ZW35-C2A	1-4	2800-6000	400-450	9.0-9.4	450	120	95-99
JH-3030W12S35-T8A	0.5	4000-6000	30-50	3.0-3.4	150	120	97-99

注:色温可定制1700-20000K
Note: CCT can be customized 1700-20000K

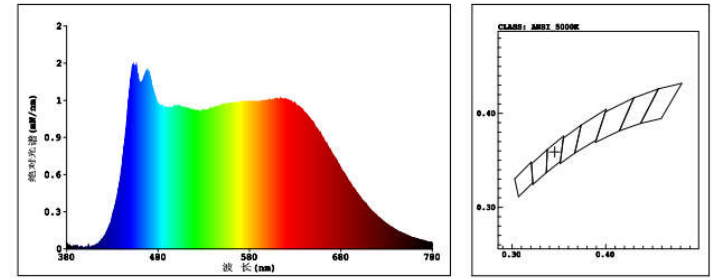

颜色参数:

色品坐标: $x=0.3455$ $y=0.3588/u'=0.2089$ $v'=0.4882$ $duv=3.419e-003$
 相关色温: $Tc=5010K$ 主波长: $\lambda_d=569.5nm$ 色纯度: $Purity=11.3\%$
 色比: $R=17.6\%$ $G=75.6\%$ $B=6.7\%$ 峰值波长: $\lambda_p=454.3nm$ 半宽度: $\Delta\lambda_d=230.3nm$
 显色指数: $Ra=93.5$ $AvgR=92.7$ $Kred=12.07\%$
 $R1=97.49$ $R2=96.51$ $R3=92.96$ $R4=91.14$ $R5=95.68$ $R6=94.62$ $R7=90.38$
 $R8=89.20$ $R9=83.30$ $R10=92.34$ $R11=94.15$ $R12=82.90$ $R13=98.77$ $R14=96.22$ $R15=94.97$

光度参数:

光子通量 $\Phi = 88.64$ lm 光效: 96.98 lm/W $\Phi_e = 319.8$ mW
 光合辐射参数 (400~700nm): 光合光子通量PPF: $1.4134\mu mol/s$
 光合有效辐射通量PAR WATT: $304.05mW$
 光合光子通量效率Eff (PPF): $1.55\mu mol/s/W$

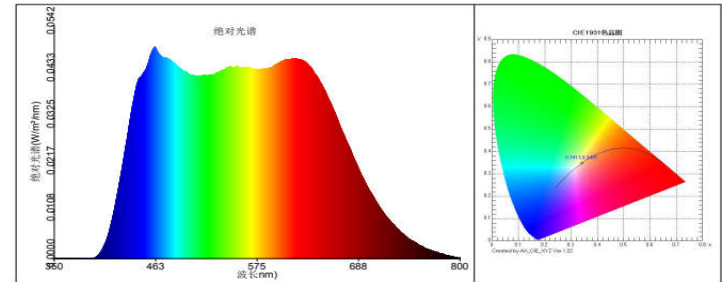

测量参数:

光照度 $E = 3531.6$ lx $E(c)=328.219$ fc
 CIE $x = 0.3413$ CIE $y = 0.3491$ CIE $u' = 0.2098$ CIE $v' = 0.4829$
 相关色温=5139 K 峰值波长=462.0 nm 半波宽=251.7 nm 主波长=570.2 nm
 色纯度=7.1 % 红色比=17.8 % 绿色比=75.5 % 蓝色比=6.7 %
 Duv=0.00025
 显色指数 $Ra=96.6$ $R1=98$ $R2=97$ $R3=97$
 $R4=97$ $R5=98$ $R6=95$ $R7=95$
 $R8=95$ $R9=92$ $R10=95$ $R11=98$
 $R12=93$ $R13=98$ $R14=99$ $R15=99$
 SDCM= 2.7(5300K/ENM)
 白光分级: C78.377_5000K
 辐照度 $1(400-700nm)=12.475$ W/m² 叶黄素A加权辐照度=1.9771 W/m² 叶黄素B加权辐照度=2.4059 W/m² 远红光辐照度=0.51152 W/m²
 蓝光辐照度=3.7089 W/m² 黄-绿辐照度=4.8224 W/m² 红-橙辐照度=3.9536 W/m²
 光合辐照度=10.597 Wphoto/m² 红蓝辐照度比=1.066
 远红光光子通量密度=3.1051E+000 $\mu mol/(m^2 \cdot s)$
 光子通量密度=57.653 $\mu mol/(m^2 \cdot s)$

植物灯贴片 Plant light SMD



2835



3030



5050

光谱图 Spectrum

2835/3030植物灯光谱

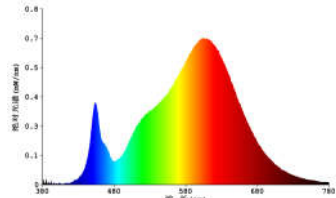

3000K

5050植物灯光谱

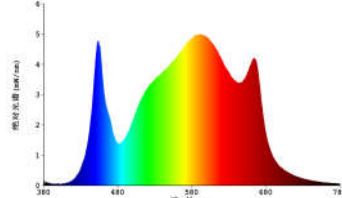

4000K

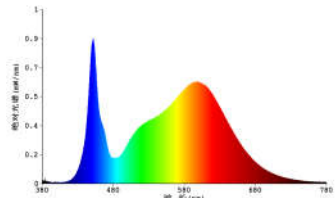

4000K

产品型号 Part No.	功率 Power(W)	色温 CCT(K)	光通量 Luminous Flux(lm)	电压 Forward Voltage(V)	电流 Forward Current(mA)	PPF($\mu\text{mol/s}$)	PPE($\mu\text{mol/j}$)
JH-3030WW12JC2639 -T10A-F80	0.2	2800-3200	30-34	2.8-3.2	60	0.47-0.49	2.8-3.0
JH-3030WW12JC2639 -T10A-F80	0.2	3800-4200	32-36	2.8-3.2	60	0.48-0.50	2.9-3.1
JH-5050WR12JC2639 -T11A-660	2	3800-4200	32-36	18-20V	90	4.2-4.4	2.5-2.7

2835/3030植物灯光谱参考

5050植物灯光谱参考

光源光谱测试报告

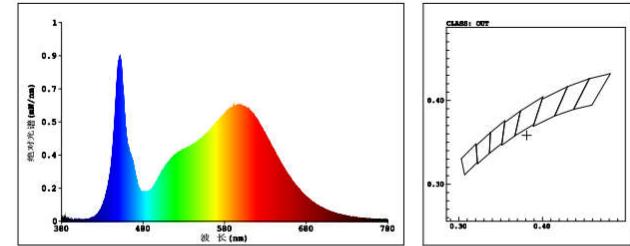

颜色参数:

色品坐标: $x=0.3811$ $y=0.3583/u'=0.2332$ $v'=0.4932$ $duv=-9.104e-003$
 相关色温: $Tc=3832K$ 主波长: $\lambda_d=586.1nm$ 色纯度: $Purity=21.9\%$
 色比: $R=19.7\%$ $G=76.6\%$ $B=3.6\%$ 峰值波长: $\lambda_p=451.9nm$ 半宽度: $\Delta\lambda_d=16.0nm$
 显色指数: $Ra=84.1$ $AvgR=78.7$ $Kred=12.56\%$
 $R1=84.38$ $R2=92.29$ $R3=94.58$ $R4=82.23$ $R5=84.53$ $R6=87.47$ $R7=83.08$
 $R8=64.38$ $R9=14.40$ $R10=80.67$ $R11=81.46$ $R12=66.52$ $R13=86.78$ $R14=97.76$ $R15=79.94$

光度参数:

光量子= $4.940e-001\mu\text{mol/s}$ 荧光蓝光比= 3.77 荧光效能= $5.152e-001$
 光通量 $\Phi = 33.76$ lm 光效: 208.97 lm/W $\Phi_e = 105.3$ mW
 光合辐射参数 (400~700nm): 光合光子通量PPF: $0.48115\mu\text{mol/s}$
 光合有效辐射通量PAR WATT: $103.15mW$
 光合光子通量效率Eff (PPF): $2.98\mu\text{mol/s/W}$

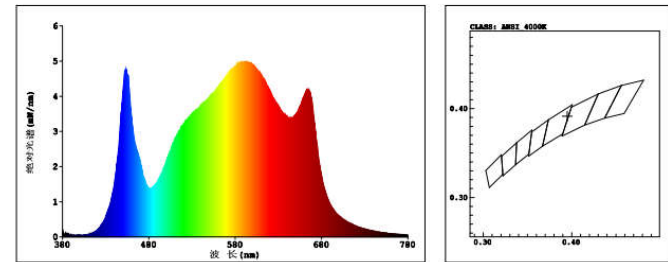

颜色参数:

色品坐标: $x=0.3949$ $y=0.3914/u'=0.2287$ $v'=0.5100$ $duv=2.767e-003$
 相关色温: $Tc=3744K$ 主波长: $\lambda_d=578.8nm$ 色纯度: $Purity=36.0\%$
 色比: $R=18.8\%$ $G=77.8\%$ $B=3.3\%$ 峰值波长: $\lambda_p=592.9nm$ 半宽度: $\Delta\lambda_d=169.7nm$
 显色指数: $Ra=84.0$ $AvgR=77.8$ $Kred=12.32\%$
 $R1=81.55$ $R2=89.20$ $R3=95.17$ $R4=81.76$ $R5=81.08$ $R6=84.33$ $R7=88.88$
 $R8=69.65$ $R9=23.51$ $R10=74.60$ $R11=79.85$ $R12=59.97$ $R13=83.33$ $R14=97.34$ $R15=77.00$

光度参数:

光量子= $4.440e+000\mu\text{mol/s}$ 荧光蓝光比= 5.24 荧光效能= $4.514e-001$
 光通量 $\Phi = 296.1$ lm 光效: 171.29 lm/W $\Phi_e = 929.2$ mW
 光合辐射参数 (400~700nm): 光合光子通量PPF: $4.3268\mu\text{mol/s}$
 光合有效辐射通量PAR WATT: $909.89mW$
 光合光子通量效率Eff (PPF): $2.50\mu\text{mol/s/W}$

专注于全光谱 LED 技术领域，
深耕于个性化，定制化市场，
欢迎广大客户参与开发，共谋发展！

Focus on full spectrum LED technology field,
Deeply in the personalized, customized market,
Welcome customers to participate in the development,
and seek common progress!



LEDGUHON
— 巨宏光电 —